

Portable Outlet Boxes

Industrial Grade - 6100/3000 Series

Portable Power



ERICSON
SAFETY IS OUR STANDARD

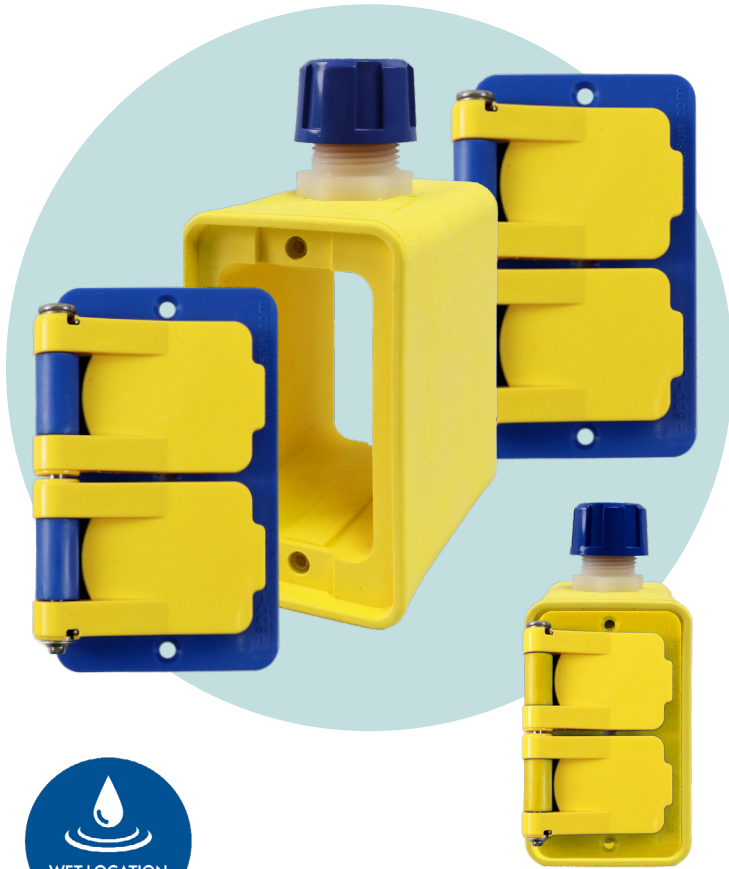

3000 Series



Industry Leading Features:

- Non-conductive TPV boxes are crush and jobsite oil resistant.
- Available in standard and extra deep depth
- Plates are available with outdoor and indoor configurations
- 6100 boxes are available with cord entrance seals that resist moisture and dust.
- Available with feed-through option for stringer applications
- Available with Wire Mesh grips for pendant and rugged applications
- Boxes accommodate 1/2 - 1" openings & countersunk for wire mesh fittings
- Custom color and configuration and drop boxes available

 **Industry Leading, Ericson Exclusive**

Unique Features:



TPV Construction for rugged applications

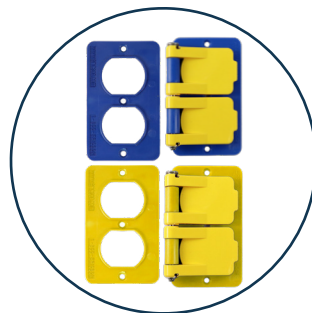

Plates available for indoor and outdoor applications



Compression Grip for secure cable and dust/moisture resistance



Optional weatherproof wire mesh available for additional strain relief

6100 Series Outdoor Boxes-Without Plates



6130

Standard Depth Box, 3-3/16"



6129

Extra Deep Box, 4-5/32"



6130B

Standard Depth Box, 3-3/16"



6129B

Extra Deep Box, 4-5/32"

6100 Series Feed-Through Boxes-Without Plates



6130-F

Standard Depth Box, 3-3/16"



6129-F

Extra Deep Box, 4-5/32"



6130B-F

Standard Depth Box, 3-3/16"



6129B-F

Extra Deep Box, 4-5/32"

6000 Series Indoor and Weather Resistant Cover Plates



6031



6031B



6032

SINGLE 1.39" OPENING



6032B



6033

SINGLE 1.572" OPENING



6033B



6034



6034B



6035



6035B



6131
Duplex
Receptacle



6131B
Duplex
Receptacle



6132
Single Receptacle
1.39" OPENING



6133
Single Receptacle
1.572" OPENING



6135
GFCI
Receptacle



6135Y
GFCI
Receptacle



6135B
GFCI
Receptacle

3000 Series Outdoor Boxes-Without Plates



3059

Standard Depth Box, 3-3/16"



3099

Extra Deep Box, 4-5/32"



3091

Standard Depth Box, 1" NPT

3000 Series Feed-Through Boxes-Without Plates



3050F

Standard Depth Box, 3-3/16"



3090F

Extra Deep Box, 4-5/32"



3091F

Standard Depth Box, 3-3/16"

3000 Series Indoor and Weather Resistant Cover Plates

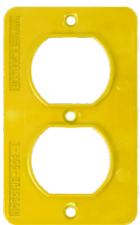

3051



3052
SINGLE 1.39"
OPENING



3055
SINGLE 1.572"
OPENING



3054



3060

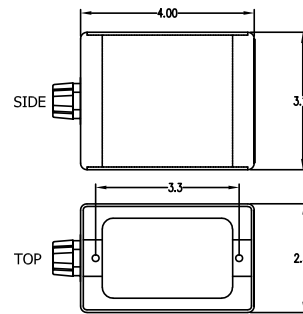

6130

STANDARD DEPTH PENDANT

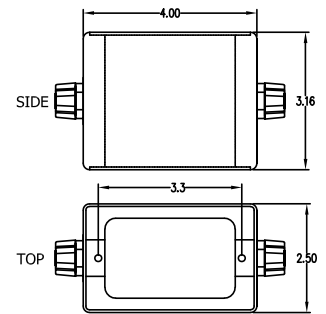

6130-F

STANDARD DEPTH FEED THROUGH



3056
Duplex
Receptacle



3057
Single
Receptacle
1.39" OPENING



3061
GFCI
Receptacle



3058
Single
Receptacle
1.572" OPENING

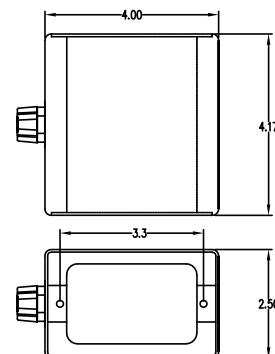

6129

EXTRA DEPTH PENDANT

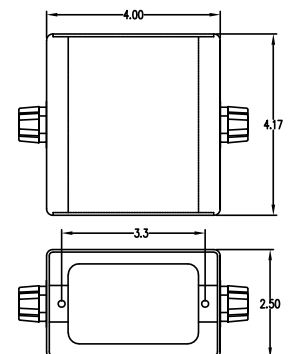

6129-F

EXTRA DEPTH FEED THROUGH

6100 Series Weather Resistant Assemblies - Standard Depth

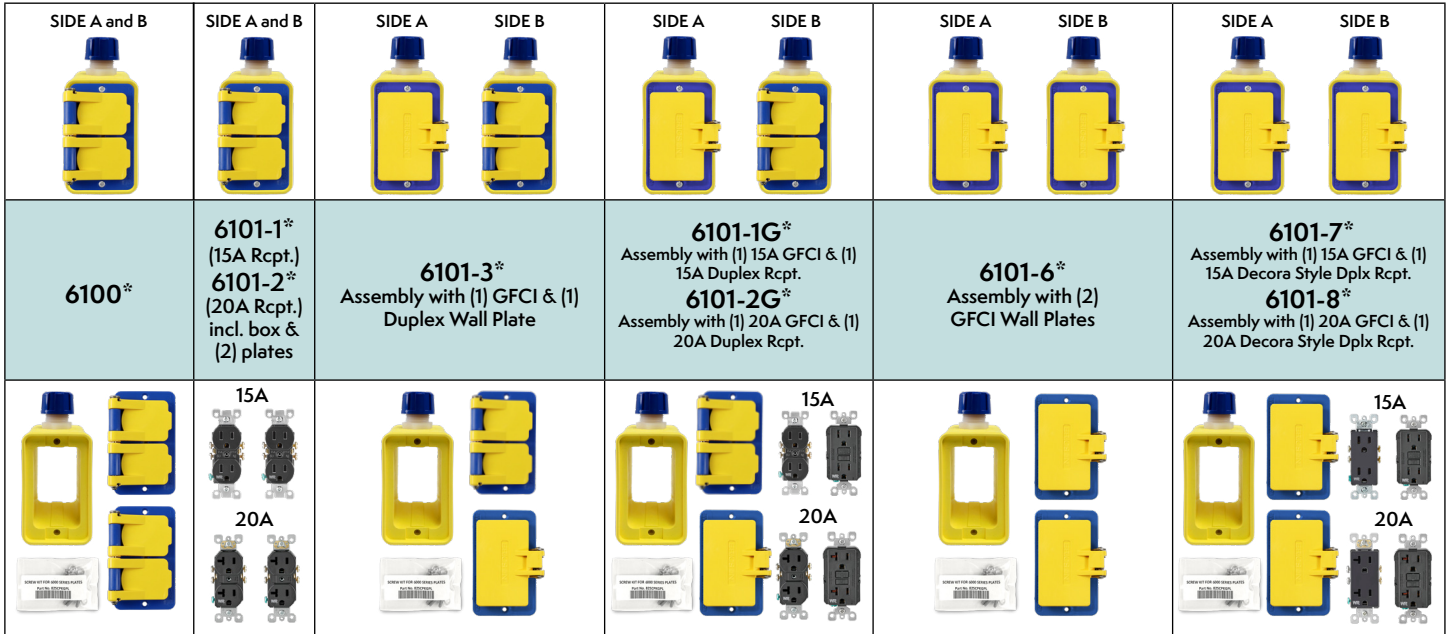

Notes: Standard depth box = 3-3/16", Extra deep box = 4-5/32"

*Available in black box and plates

Standard Depth (Non-Feedthrough)							
Part Number	Color	Indoor & Weather Resistant***	Cord Grip Bushing	Box Depth	Bushing provided, NPT (inch)	Plates Included	Receptacles Included
6100	Yellow	Weather Resistant	Grip	Standard	1/2"	(2) Duplex 6131	None
6100B	Black	Weather Resistant	Grip	Standard	1/2"	(2) Duplex 6131B	None
6101-1	Yellow	Weather Resistant	Grip	Standard	1/2"	(2) Duplex 6131	(2) 5-15 Duplex
6101B-1	Black	Weather Resistant	Grip	Standard	1/2"	(2) Duplex 6131	(2) 5-15 Duplex
6101-2	Yellow	Weather Resistant	Grip	Standard	1/2"	(2) Duplex 6131	(2) 5-20 Duplex
6101B-2	Black	Weather Resistant	Grip	Standard	1/2"	(2) Duplex 6131B	(2) 5-20 Duplex
6101-1G	Yellow	Weather Resistant	Grip	Standard	1/2"	(2) GFCI 6135	(2) 5-15 GFCI Dplx
6101B-1G	Black	Weather Resistant	Grip	Standard	1/2"	(2) GFCI 6135B	(2) 5-15 GFCI Dplx
6101-2G	Yellow	Weather Resistant	Grip	Standard	1/2"	(2) GFCI 6135	(2) 5-20 GFCI Dplx
6101B-2G	Black	Weather Resistant	Grip	Standard	1/2"	(2) GFCI 6135B	(2) 5-20 GFCI Dplx
6101-3	Yellow	Weather Resistant	Grip	Standard	1/2"	(1) GFCI 6135 & (1) Duplex 6131	None
6101B-3	Black	Weather Resistant	Grip	Standard	1/2"	(1) GFCI 6135B & (1) Duplex 6131	None
6101-6	Yellow	Weather Resistant	Grip	Standard	1/2"	(2) GFCI 6135	None
6101B-6	Black	Weather Resistant	Grip	Standard	1/2"	(2) GFCI 6135B	None
6101-7	Yellow	Weather Resistant	Grip	Standard	1/2"	(2) GFCI 6135	(1) 5-15 GFCI Rcpt & (1) 5-15 Decora Rcpt
6101B-7	Black	Weather Resistant	Grip	Standard	1/2"	(2) GFCI 6135B	(1) 5-15 GFCI Rcpt & (1) 5-15 Decora Rcpt
6101-8	Yellow	Weather Resistant	Grip	Standard	1/2"	(2) GFCI 6135	(1) 5-20 GFCI Rcpt & (1) 5-20 Decora Rcpt
6101B-8	Black	Weather Resistant	Grip	Standard	1/2"	(2) GFCI 6135B	(1) 5-20 GFCI Rcpt & (1) 5-20 Decora Rcpt
6130	Yellow	*	Grip	Standard	1/2"	None	None
6130B	Black	*	Grip	Standard	1/2"	None	None
6130-34	Yellow	*	None	Standard	3/4" CB	None	None
6130B-34	Black	*	None	Standard	3/4" CB	None	None

Note:

*Yellow boxes include blue plates

*Black boxes include black plates

**Included receptacles are black

***Environmental rating is dependent on the type of plate used (indoor or outdoor)

6100 Series Weather Resistant Assemblies - Extra Deep

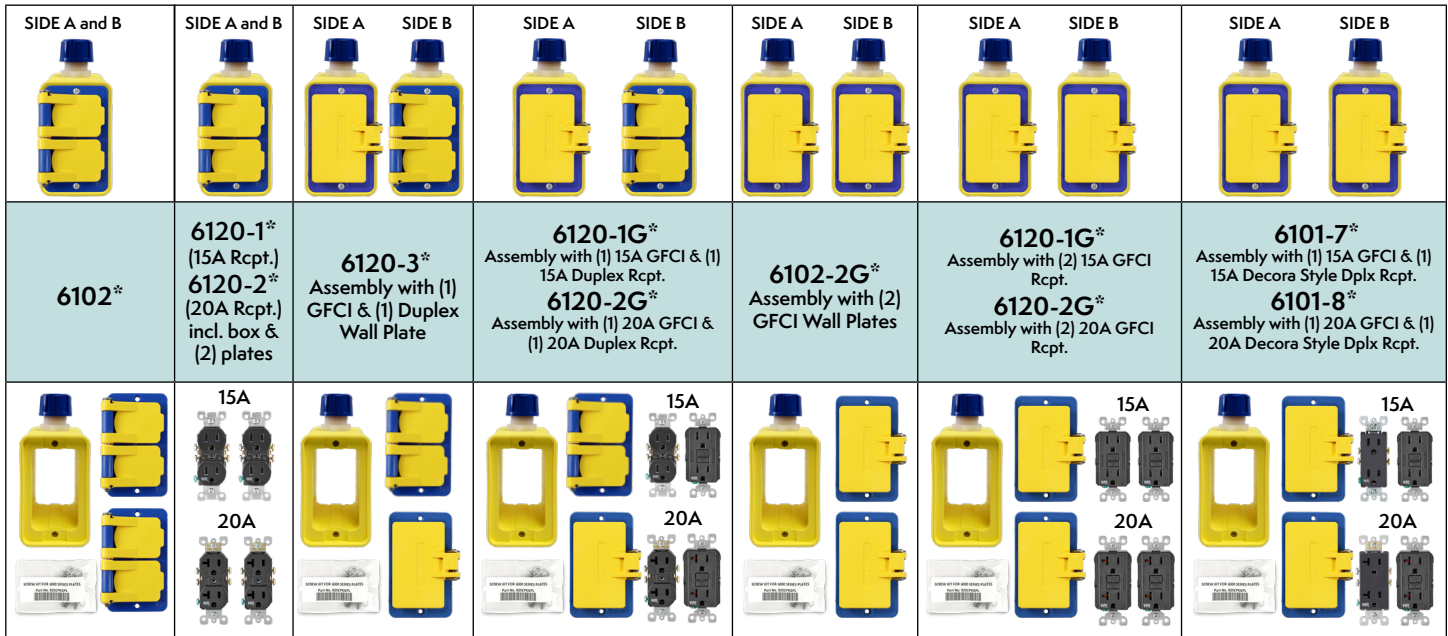

Notes: Standard depth box = 3-3/16", Extra deep box = 4-5/32"

*Available in black box and plates

Extra Deep (Non-Feedthrough)							
Part Number	Color	Indoor & Weather Resistant***	Cord Grip Bushing	Box Depth	Bushing provided, NPT (inch)	Plates Included	Receptacles Included
6002-34N	Yellow	Indoor	Grip	Extra Deep	3/4"	(2) Duplex 6031	None
6102	Yellow	Weather Resistant	Grip	Extra Deep	1/2"	(2) Duplex 6131	None
6102B	Black	Weather Resistant	Grip	Extra Deep	1/2"	(2) Duplex 6131B	None
6120-1	Yellow	Weather Resistant	Grip	Extra Deep	1/2"	(2) Duplex 6131	(2) 5-15 Duplex
6120B-1	Black	Weather Resistant	Grip	Extra Deep	1/2"	(2) Duplex 6131	(2) 5-15 Duplex
6120-2	Yellow	Weather Resistant	Grip	Extra Deep	1/2"	(2) Duplex 6131	(2) 5-20 Duplex
6120B-2	Black	Weather Resistant	Grip	Extra Deep	1/2"	(2) Duplex 6131B	(2) 5-20 Duplex
6120-1G	Yellow	Weather Resistant	Grip	Extra Deep	1/2"	(2) GFCI 6135	(2) 5-15 GFCI Dplx
6120B-1G	Black	Weather Resistant	Grip	Extra Deep	1/2"	(2) GFCI 6135B	(2) 5-15 GFCI Dplx
6120-2G	Yellow	Weather Resistant	Grip	Extra Deep	1/2"	(2) GFCI 6135	(2) 5-20 GFCI Dplx
6120B-2G	Black	Weather Resistant	Grip	Extra Deep	1/2"	(2) GFCI 6135B	(2) 5-20 GFCI Dplx
6120-3	Yellow	Weather Resistant	Grip	Extra Deep	1/2"	(1) GFCI 6135 & (1) Duplex 6131	None
6120B-3	Black	Weather Resistant	Grip	Extra Deep	1/2"	(1) GFCI 6135B & (1) Duplex 6131	None
6102-2G	Yellow	Weather Resistant	Grip	Extra Deep	1/2"	(2) GFCI 6135	None
6102B-2G	Black	Weather Resistant	Grip	Extra Deep	1/2"	(2) GFCI 6135B	None
6120-7	Yellow	Weather Resistant	Grip	Extra Deep	1/2"	(2) GFCI 6135	(1) 5-15 GFCI Rcpt & (1) 5-15 Decora Rcpt
6120B-7	Black	Weather Resistant	Grip	Extra Deep	1/2"	(2) GFCI 6135B	(1) 5-15 GFCI Rcpt & (1) 5-15 Decora Rcpt
6120-8	Yellow	Weather Resistant	Grip	Extra Deep	1/2"	(2) GFCI 6135	(1) 5-20 GFCI Rcpt & (1) 5-20 Decora Rcpt
6120B-8	Black	Weather Resistant	Grip	Extra Deep	1/2"	(2) GFCI 6135B	(1) 5-20 GFCI Rcpt & (1) 5-20 Decora Rcpt
6129	Yellow	*	Grip	Extra Deep	1/2"	None	None
6129B	Black	*	Grip	Extra Deep	1/2"	None	None
6129-34	Yellow	*	None	Extra Deep	3/4" CB	None	None
6129B-34	Black	*	None	Extra Deep	3/4" CB	None	None
6129-34N	Yellow	*	None	Extra Deep	3/4"	None	None
6129B-34N	Black	*	None	Extra Deep	3/4"	None	None

6100 Series Feed-Through Style - Indoor & Weather Resistant Assemblies Standard and Extra Deep Depth

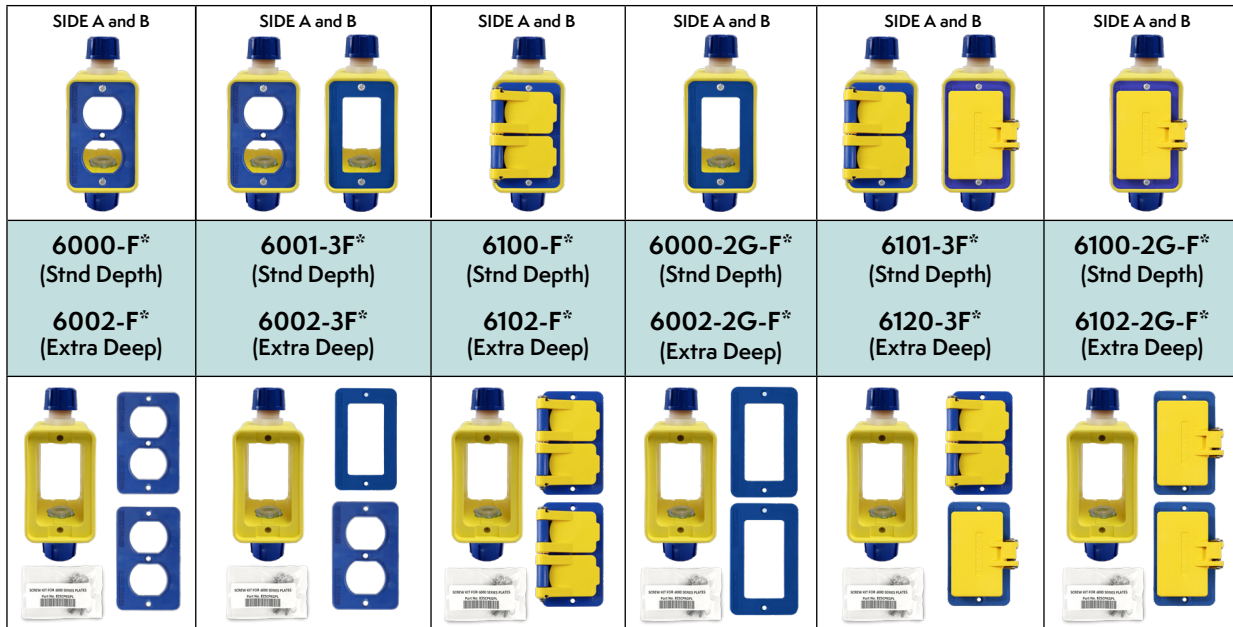

Notes: Standard depth box = 3-3/16",
Extra deep box = 4-5/32"

*Available in black box and plates

**Not shown

Indoor Feed Through - Standard Depth & Extra Deep							
Part Number	Color	Indoor & Weather Resistant	Cord Grip Bushing	Box Depth	Bushing provided, NPT (inch)	Plates Included	Receptacles Included
6000-F	Yellow	Indoor	Grip	Standard	1/2"	(2) Duplex 6031	None
6000B-F	Black	Indoor	Grip	Standard	1/2"	(2) Duplex 6031B	None
6000-2G-F	Yellow	Indoor	Grip	Standard	1/2"	(2) GFCI 6035	None
6000B-2G-F	Black	Indoor	Grip	Standard	1/2"	(2) Duplex 6035B	None
6001-3F	Yellow	Indoor	Grip	Standard	1/2"	(1) 6031 & (1) 6135	None
6001B-3F	Black	Indoor	Grip	Standard	1/2"	(1) 6031B & (1) 6135B	None
6002-3F	Yellow	Indoor	Grip	Extra Deep	1/2"	(1) 6031 & (1) 6135	None
6002B-3F	Black	Indoor	Grip	Extra Deep	1/2"	(1) 6031B & (1) 6135B	None
6002-F	Yellow	Indoor	Grip	Extra Deep	1/2"	(2) Duplex 6031	None
6002B-F	Black	Indoor	Grip	Extra Deep	1/2"	(2) Duplex 6031	None
6002-2G-F	Yellow	Indoor	Grip	Extra Deep	1/2"	(2) GFCI 6035	None
6002B-2G-F	Black	Indoor	Grip	Extra Deep	1/2"	(2) Duplex 6035B	None
Outdoor Feed Through - Standard Depth & Extra Deep							
6100-F	Yellow	Weather Resistant	Grip	Standard	1/2"	(2) Duplex 6131	None
6100B-F	Black	Weather Resistant	Grip	Standard	1/2"	(2) Duplex 6131B	None
6101-3F	Yellow	Weather Resistant	Grip	Standard	1/2"	(1) 6031 & (1) 6135	None
6101B-3F	Black	Weather Resistant	Grip	Standard	1/2"	(1) 6031B & (1) 6135B	None
6120-3F	Yellow	Weather Resistant	Grip	Extra Deep	1/2"	(1) 6031 & (1) 6135	None
6120B-3F	Black	Weather Resistant	Grip	Extra Deep	1/2"	(1) 6031B & (1) 6135B	None
6100-2G-F	Yellow	Weather Resistant	Grip	Standard	1/2"	(2) GFCI 6135-Y	None
6100B-2G-F	Black	Weather Resistant	Grip	Standard	1/2"	(2) GFCI 6135B	None
6102-F	Yellow	Weather Resistant	Grip	Extra Deep	1/2"	(2) Duplex 6131	None
6102B-F	Black	Weather Resistant	Grip	Extra Deep	1/2"	(2) Duplex 6131B	None
6102-2G-F	Yellow	Weather Resistant	Grip	Extra Deep	1/2"	(2) GFCI 6135-Y	None
6102B-2G-F	Black	Weather Resistant	Grip	Extra Deep	1/2"	(2) GFCI 6135B	None
6130-F	Yellow	*	Grip	Standard	1/2"	None	None
6130B-F	Black	*	Grip	Standard	1/2"	None	None
6129-F	Yellow	*	Grip	Extra Deep	1/2"	None	None
6129B-F	Black	*	Grip	Extra Deep	1/2"	None	None
6129-34-F	Yellow	*	None	Extra Deep	3/4" CB	None	None
6129B-34-F	Black	*	None	Extra Deep	3/4" CB	None	None

Note: *Environmental rating is dependent on the type of plate used (indoor or outdoor)

Diameter Ranges of Portable Electrical Cord in Accordance with UL 62

Type	AWG Size	2 Conductors	3 Conductors	4 Conductors
SJ, SJE, SJOO, SJO, SJEO, SJT, SJTO, SJTOO	18	0.280-0.315	0.300-0.335	0.325-0.365
	16	0.305-0.340	0.325-0.360	0.350-0.395
	14	0.335-0.375	0.360-0.395	0.390-0.435
	12	0.405-0.455	0.425-0.475	0.465-0.520
	10	0.540-0.605	0.565-0.635	0.625-0.700
S, SE, SOO, SO, SEO, ST, STOO, STO	18	0.340-0.385	0.360-0.400	0.385-0.430
	16	0.365-0.410	0.385-0.430	0.410-0.460
	14	0.495-0.550	0.520-0.575	0.560-0.620
	12	0.565-0.625	0.590-0.655	0.640-0.710
	10	0.615-0.685	0.650-0.720	0.700-0.775

6100 and 3000 Series Box Strain Relief Kits

Indoor Galvanized Aluminum Wire Mesh Strain Relief		
Size	Part Number	Cable Range
1/2" NPT	SR-022	.24-.32
1/2" NPT	SR-030	.32-.43
1/2" NPT	SR-040	.43-.54
3/4" NPT	SR-052	.54-.73
1" NPT	SR-070	.73-.97



Dry location only.

Outdoor Watertight Deluxe Stainless Steel Wire Mesh Strain Relief		
Size	Part Number	Cable Range
1/2" NPT	DCG-43-F2	.31-.43
1/2" NPT	DCG-50-F2	.37-.50
3/4" NPT	DCG-50-F3	.37-.50
3/4" NPT	DCG-62-F3	.50-.62
3/4" NPT	DCG-75-F3	.62-.75
1" NPT	DCG-75-F4	.62-.75
1" NPT	DCG-87-F4	.75-.87
1" NPT	DCG-100-F4	.87-1.0



Replacement Screws for 6000 Series Plates		
Part Number	Description	
60SCPkg	Screw Package for 6000 Series	

Nonmetallic Cord Grips Kit <i>(Includes cord grip insert, grip nut, and lock nut)</i>		
Non-Metallic Cord Grip	Part Number	Cable Range
1/2" NPT	82005	.37-.61
1/2" NPT	82005B	.37-.61
3/4" NPT	82034	.45-.70
1" NPT	82010	.59-1.0



Metallic Lock Nuts	
Size	Part
1/2" NPT	Locknut-50
3/4" NPT	Locknut-75
1" NPT	Locknut-100



Note: 6100 Series are supplied standard with Non-Metallic Cord Grip

MAX CORD DIA. (inch)	B10200XX*					Catalog #
	Small White OVAL #24	Small Orange OVAL #25	Small Yellow #21	Small White #20	Small Red #16	
.160 x .360	OVAL (UF)	OVAL (UF)	.370	.450	.560	6130
.230 x .440	Optional	Optional	Yellow	White	Red	6129
			✓	✓	✓	6130B
			✓	✓	✓	6129B
			✓	✓	✓	6130-F
			✓	✓	✓	6129-F
			✓	✓	✓	6130B-F
			✓	✓	✓	6129B-F



Note:

To build a grommet catalog number replace the "XX" with grommet number desired, e.g. B1020021

*May be ordered separately - Call for details

Related Products:

Click or scan a QR code to learn more about our products.

Scan here to visit
ericson.com



6000/3000 Series



Perma-Link



Perma-Grip



Perma-Tite



Smart Monitor



Smart Monitor Watertight IP69K



PWDX Series



FS Series



I-Grips & Support Grips



Factory Assembled Power Drops



8000/3200 Series



Industrial Cord Reel Series



Ericson Manufacturing Company
4323 Hamann Parkway
Willoughby, OH 44094, USA



1-800-ERICSON
info@ericson.com
L1000886D
REV 1.15.25